

Article number: 20187012

Description: E+G

Indexing plunger GN 717-4-M6-B-ST

Measures

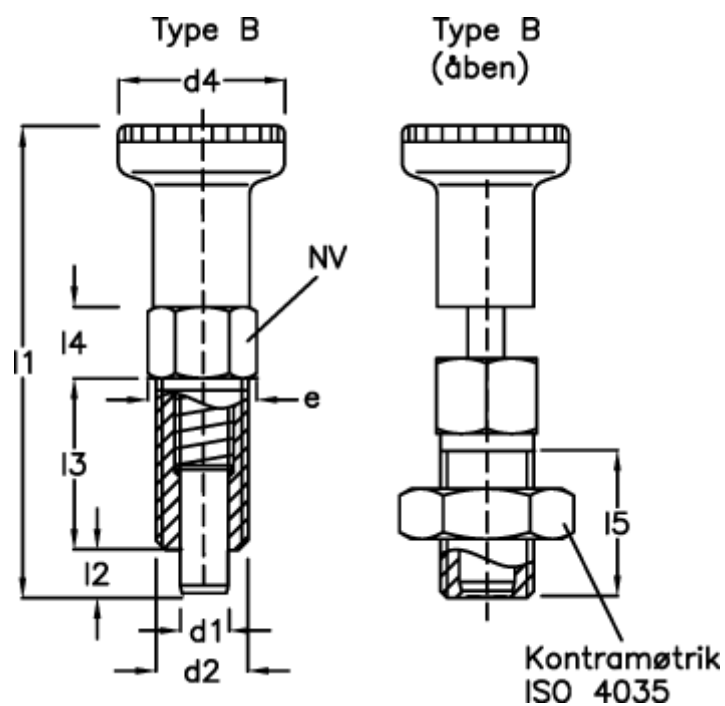

$d1 = 4$	$l5$	$= 10.0$
$d2 = M6$	NV	$= 6$
$d4 = 12$	Spring pressure N bottom	$= 12$
$e = 6.9$	Spring pressure N top	$= 3$
$l1 = 30.5$		
$l2 = 4$		
$l3 = 12$		
$l4 = 4.5$		